



tigerlight®

HIGH-PERFORMANCE
INDUSTRIAL LIGHTING

MAKO BULKHEAD LIGHT
BULKHEAD EMERGENCY



MAKO
BULKHEAD



MAKO BULKHEAD LIGHT MAKO BULKHEAD EMERGENCY LIGHT

Industrial-quality high-performance wall-mounted luminaire
IP66 and IK10 rated for robust environments
Nominal output: 30W - 4,120 lm 40W - 5,500 lm 50W - 6,820 lm
Efficacy 150+ lm/W
Range of optical lenses to suit wide or narrow areas
Emergency option for additional level of safety and security.

SIZES & OPTIONS



MAKO BULKHEAD

Nominal LCP	30W	40W	50W
Luminous Flux	4,120 lm	5,500 lm	6,820 lm
LED drive current	530mA	700mA	875mA
Weight	3.1kg.		

MAKO BULKHEAD EMERGENCY

Nominal LCP	30W	40W
Luminous Flux	4,120 lm	5,500 lm
Maintained emergency	Run-time 3hrs @ 5W. 645 lm	
Weight	3.6kg.	



BULKHEAD U-BRACKET OPTION

Mako Bulkhead light comes with flush ceiling or wall mounting as standard (as pictured above).

U-Bracket (right) is available as an optional extra.

Product code BLBULKBKT



OPTICAL LENS OPTIONS

Type T5W lenses are standard configuration.
(Square wide, approximately equivalent to 120°)
Other lenses available on special order, including T60 round and asymmetrical options.

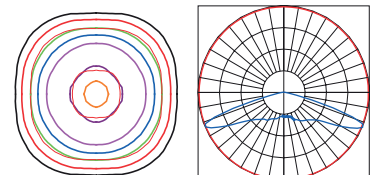



MODEL NUMBER SYSTEM

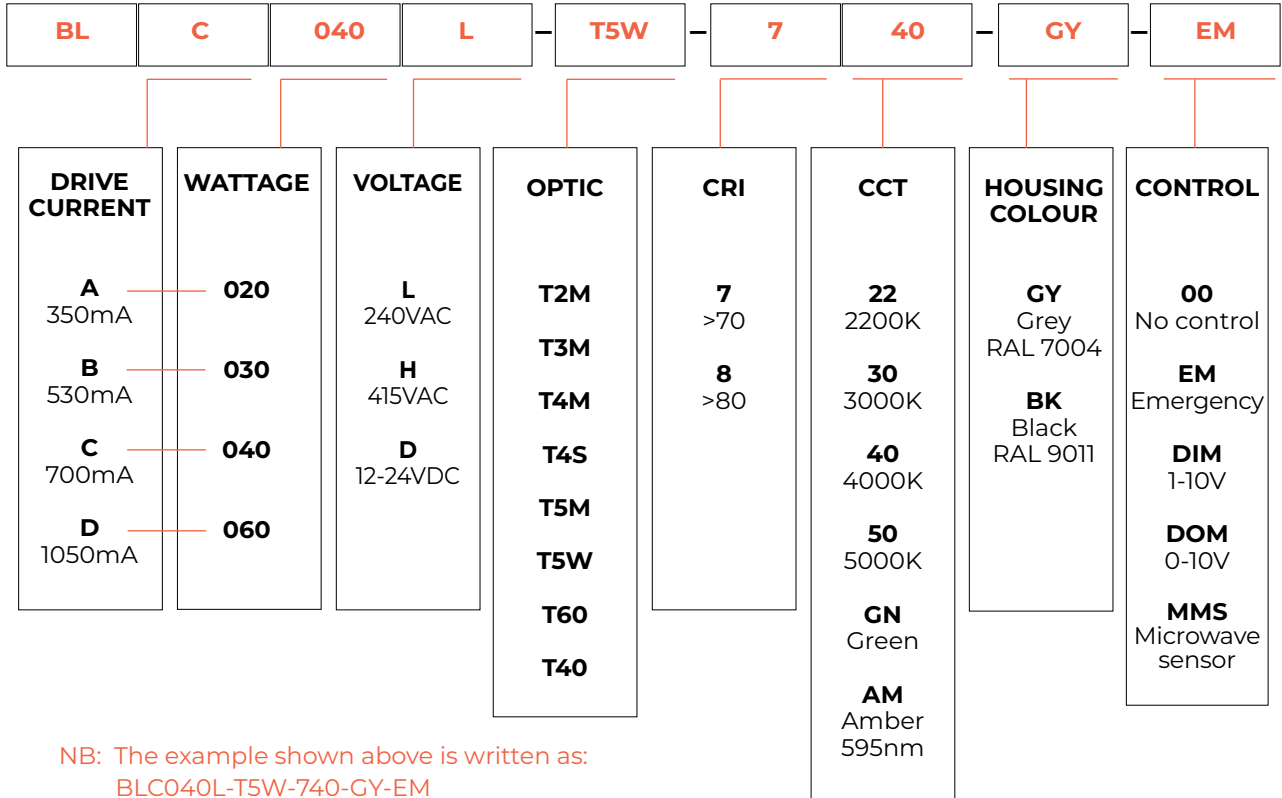

APPLICATIONS

Industrial bulkhead area lighting for walls & ceilings, from 2.4 to 6m high, indoors or outdoors. For use around industrial plants, mine sites, out-buildings, storage areas, walkways and gantries, and in poultry sheds.

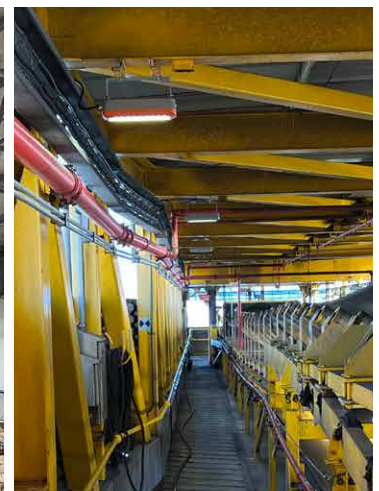



MAKO BULKHEAD LIGHT

Voltages	120-277VAC, 50/60HZ
Power options	40W standard. 30W, 50W nominal
LED chip drive current	30W - 530mA, 40W - 700mA, 50W - 875mA
Luminous flux	30W - 4120 lm, 40W - 5500 lm, 50W - 6820 lm
Operating Temperatures	-40 to +50deg C
Efficacy	150+ lm/W
Initial Chromaticity	MacAdam 5
CCT	4000K std, 2200, 2700, 3000, 5000K options
CRI options	Ra>70 std, >80, >90
Optical lens options	T5W standard. Options Types 2, 3 & 4
IP / IK Rating	IP66 / IK10
Power factor	>0.95 at full load
Control Options	1-10V, DALI, NEMA 3 / 7
Surge Protection	Imax 20KA
L70B10 / L90B10	>200,000hrs. / >60,000hrs
Mounting brackets	Flat bracket standard, U-Bracket option.
Dimensions	364Lx140Wx82mmH
Cable entry diameter	10-14mm
Weight	3.1kg
Housing	Die Cast Aluminium
Colour	Black or grey
Surface Treatment	Polyester powdercoat min 100µm
Certification	SAA, CE 
Warranty	5 years.

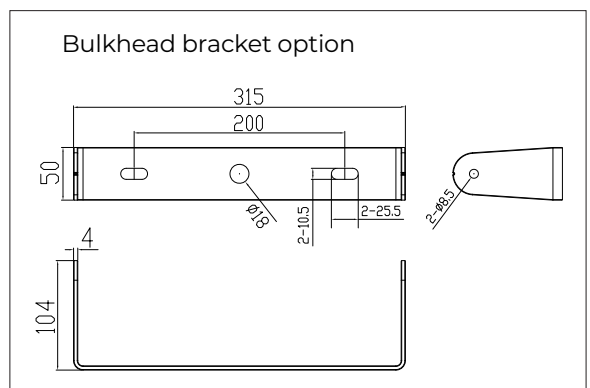
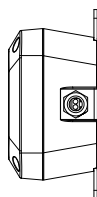
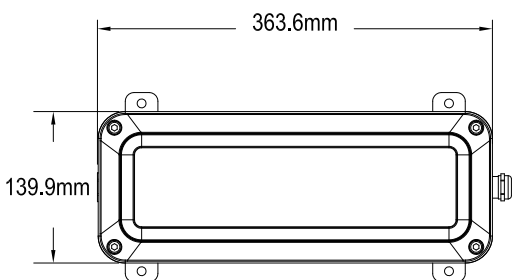
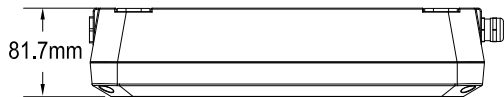



MAKO BULKHEAD EMERGENCY LIGHT

Emergency Type	Maintained
Wattage	40W
Input Voltage	120-277VAC
Lumen Output	5500 lm
Emergency Output	5W - 645 lm
Emergency Runtime	3 hours
Testing System	Self test via button
Operating Temp	0 – 40°C
IP Rating	IP66
Battery	LiFe PO4
Battery Voltage	6.4V
Battery Capacity	3200mAh
Classification	C0:D100 C90:D100
Certification	ASNZ 2293.3
Weight	3.6kg
Dimensions / EPA	364L x 140W x 82mmH
Cable entry diameter	10-14mm
Warranty	3 years.

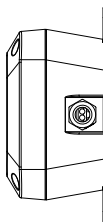
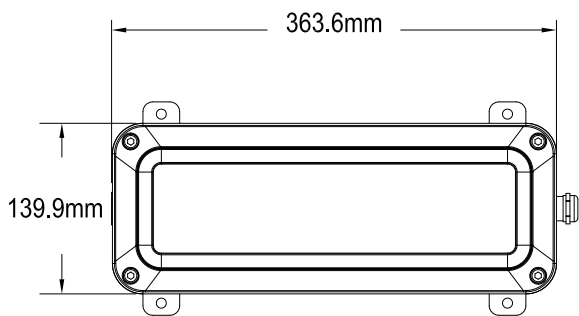
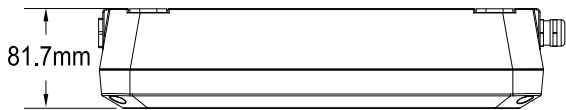



tigerlight[®]

T 1300 184 437
F 02 9913 8876
E info@tigerlight.com.au

**National Support &
Distribution Centre**
Unit 8, 1 Vuko Place,
Warriewood, NSW 2102

**Western Australia
Office & Warehouse**
Unit 3, 1 Distinction Road,
Wangara, WA 6065

tigerlight.com.au

 [Tigerlight Pty Ltd](#)

 [TigerlightLED](#)

All documentation is subject to change without notice. © 20240619

